

Multifunction SL50

and its remote control

Product reference : 90-60-445 white / 90-60-472 carbon



USER GUIDE and INSTALLATION GUIDE

nke – Sailing competition

Z.I. Kerandré – Rue Gutenberg – 56700 HENNEBONT- FRANCE
<http://www.nke.fr> – N° indigo 0 892 680 656 : 0.34€/min.

TABLE OF CONTENT

1 USING	3
1.1 PRESENTATION	3
1.2 LIST OF CHANNELS CREATED	5
1.3 KEYPAD FUNCTIONS OF THE REMOTE CONTROL	6
1.4 CHANNEL SELECTION	7
1.5 WHAT IS A SUB-CHANNEL	7
1.6 ALARMS SETTING	8
1.7 FILTERING OF THE CHANNELS	9
1.8 LIGHTING SETTING	10
1.9 CHOICE OF THE UNIT	10
1.10 CALIBRATION OF SENSORS	13
1.11 AUTOCOMPENSATION OF THE FLUXGATE COMPASS	14
1.12 ZERO SETTING OF THE DAILY LOG	11
1.13 CHOICE OF LANGUAGES	10
1.14 USE OF THE CHRONOMETER	12
1.15 TECHNICAL SPECIFICATIONS	14
1.16 VERSION AND ADDRESS NUMBER OF THE DISPLAY	15
1.17 DIAGNOSTIC FOR 1 ST LEVEL TROUBLESHOOTING.	15
1.18 <i>SL50</i> INITIALISATION : SEE CHAPTER 4.8	15
2 INSTALLATION.....	16
2.1 PACKING LIST :	16
2.2 LIST OF ACCESSORIES	16
2.3 INSTALLATION PRECAUTIONS	16
2.4 MOUNTING ON MAST FOOT SUPPORT	17
2.5 WALL MOUNTING.....	17
2.6 CONNECTION TO THE <i>TOPLINE BUS</i>	19
2.7 IDENTIFICATION OF THE CABLE WIRES	19
2.8 <i>SL50</i> AND REMOTE CONTROL INITIALISATION	20

1 USING

1.1 Presentation

The **Multifunction SL50** is a display from the **TOPLINE** range. Its screen, with high definition LCD technology, offer excellent readability and a wide angle of view of the data displayed, whether by daylight or at night. It is connected to the **TOPLINE bus** of your installation and displays all the channels available on the bus.

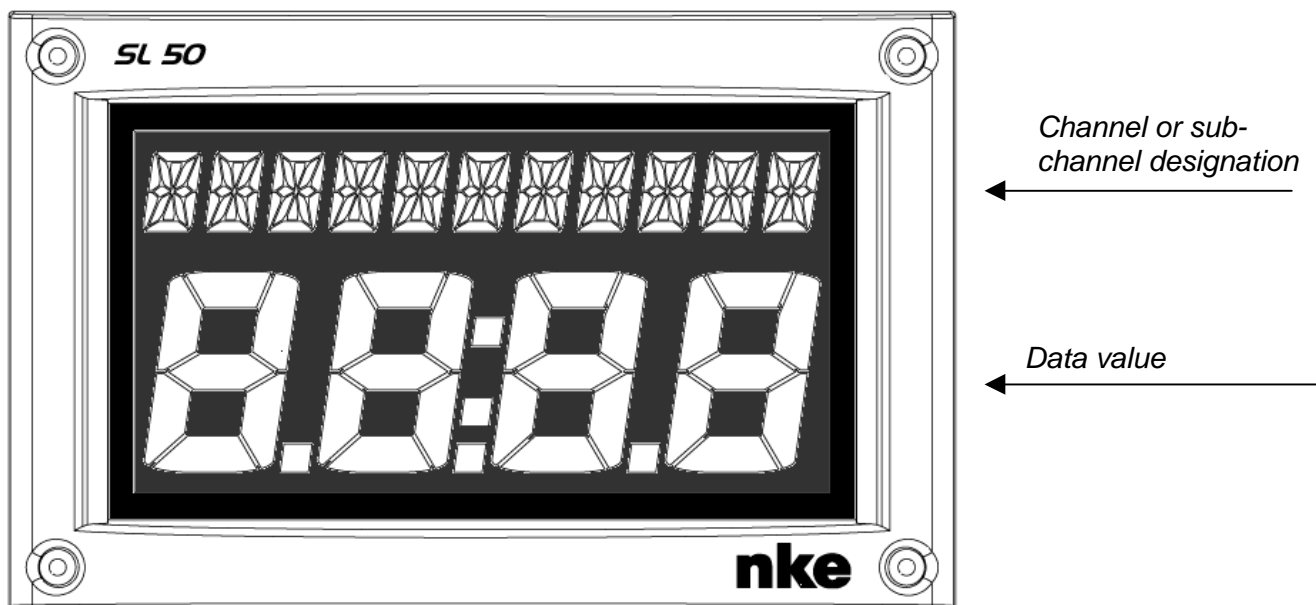

The **SL50** is controlled using either a cable remote control or a radio remote control (not included with the product).



Architecture of the installation

The presence of the equipment in the following diagram is for information only, and does not represent the equipment of your installation.

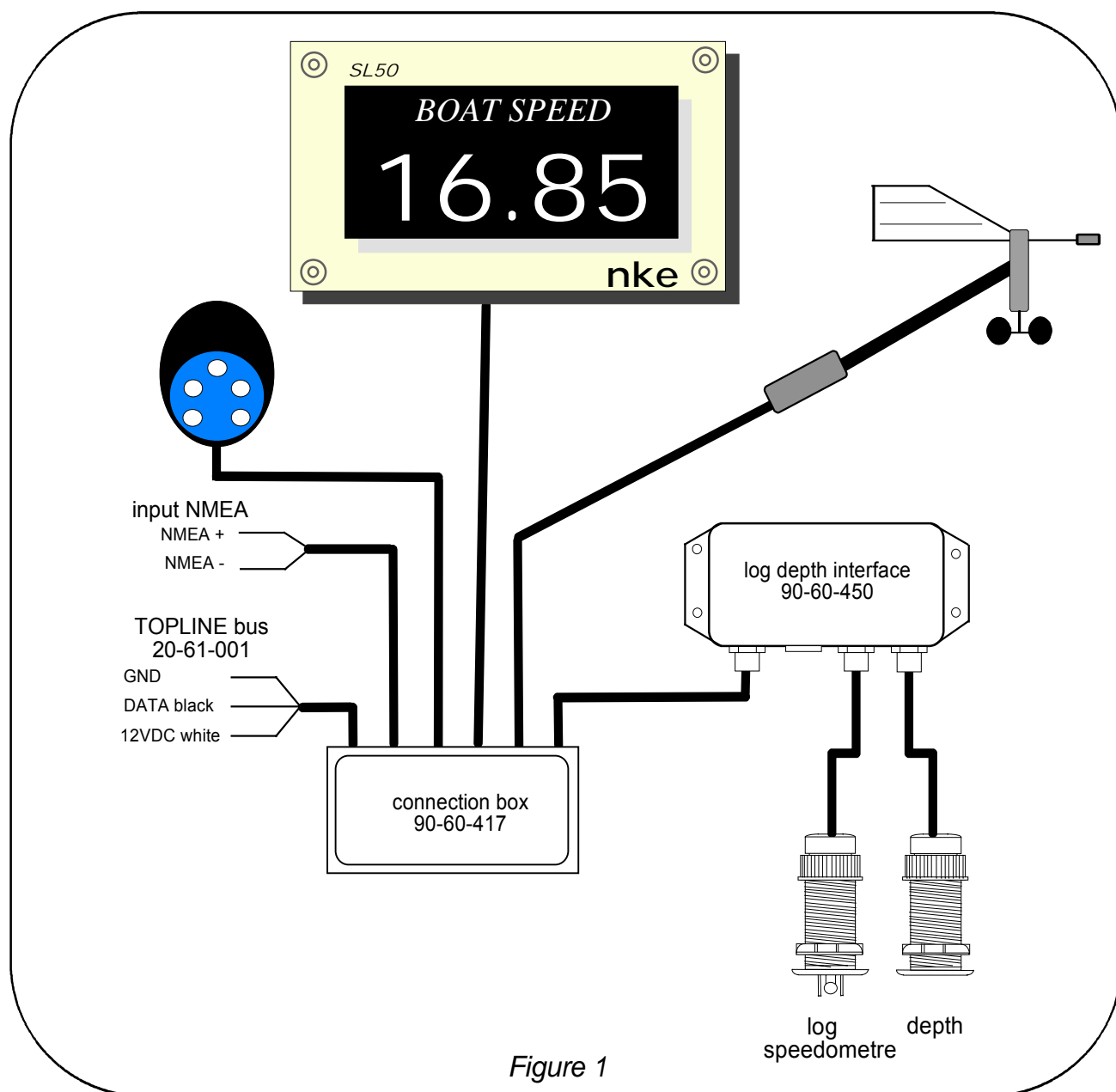



Figure 1

1.2 List of channels created

The master display, whether it is the **SL50** or any other **TOPLINE** display, and each **TOPLINE** sensor, automatically create their respective channels when they are connected to the **TOPLINE bus**.

	Channel designation
Channels created by the SL50 when set as master display	Magnetic heading
	Apparent wind angle
	Apparent wind speed
	Depth
	Surface speed
	Maximum and average speed
	Distance and heading to man over board
	Configuration
	Bus voltage
	VMG
	CMG
	True wind speed
	True wind angle
	True wind direction
	Corrected heading
	Estimated distance
	Estimated angle
	Total log
Daily log	
NMEA Performance channels displayed	Target speed
	Heading on other side
	Optimum wind angle
NMEA channels displayed	Optimum VMG angle
	Optimum CMG angle
	Efficiency at close-haul
	Polar efficiency
	Bottom speed and bottom heading
	Cross-track error

Please note that the channels **MAX SPD** and **AVERAGE SPD** can be accessed when the **SL50** is master. By default, these channels are calculated using the surface speed, and in the absence of the latter it will be calculated using the bottom speed. These average and maximum values are calculated from the last power-up of your installation. You can reset these channels to zero, without switching off the bus : select the channel **MAX SPD** and **AVERAGE SPD** then press the  key for 2 seconds.

1.3 Keypad functions of the remote control

-  **Low key** and  **High key**

These keys allow to select a different channel to the one already displayed. They also allow to increment or decrement a data which is in the process of being modified.

-  **key**

The remote control also enables you to control the other displays of your **TOPLINE** installation, the address of which is lower than the address of the remote control. Press this key to select the **TOPLINE** display, which you wish to operate.

-  **key**

This key allows to access the sub-channels and to validate the settings you implement. Brief pressure on this key also allows to set the level of lighting.

-  **Man Over Board key**

Press this key for 5 seconds, and the function «Man Over Board» is activated. When a speedometer and a compass are connected to the **TOPLINE bus**, the displays then automatically indicate the estimated bearing and distance to reach the man over board. If your installation only comprises a speedometer, then only the estimated distance will be displayed.

To disable the «Man Over Board» alarm, you must cut off the power supply of your **TOPLINE** installation.

CAUTION : the calculation of the estimate, for the Man Over Board function, does not take into account the drift of the boat caused by the current and the wind.

For more detailed information, please refer to the remote control user guide.

-  **Key**



This key is useless for the **Multifunction SL50**.

1.4 Channel selection

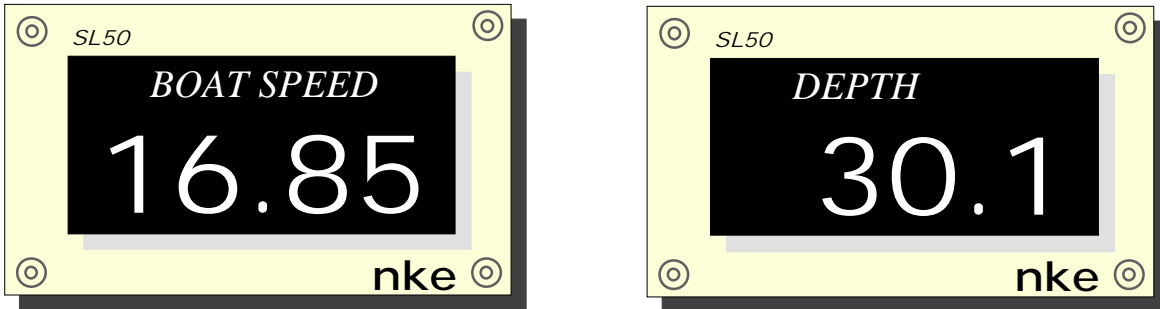
Using the remote control, configure the display according to your requirements. Examples of configuration:



Procedure

- Using the keys  and , you can select in the list the channel you wish to display.
- The new channel to display is recorded.

CAUTION : if your installation is equipped with several **TOPLINE** displays, make sure that the remote control controls the display which you wish to operate. Press the  key repeatedly, until the intended display blinks.

1.5 What is a sub-channel

The sub-channels are made to modify setting and display parameters of the channels. For example, the sub-channels of the **surface speed** channel are:

- the **offset** and the **calibration coefficient** : setting parameters of the log-speedometer sensor,
- the measurement **unit** : in knots or in km/hr,
- the **filter** setting,
- the setting of the **upper alarm** and the **lower alarm**.

The same applies to all channels present on the **TOPLINE bus**. The following chapters provide detailed explanations on how to access the sub-channels and implement the settings.

1.6 Alarms setting

The setting of an alarm enables you to monitor the value of a channel. When the preset threshold is exceeded, a warning message is displayed and an audible alarm is activated. For example, you can set an upper threshold and a lower threshold on the **surface speed** channel.

The upper alarm is activated when the display is higher than the programmed threshold.

The lower alarm is activated when the display is lower than the programmed threshold.

To cancel the alarm of a channel, enter the value **0** in the upper alarm and the lower alarm.

Thus, the setting of the alarms will allow you to supervise your **TOPLINE** installation effectively as well as the good operation of your boat.

Note that for angular channels such as **magnetic heading** or **wind angle**, the sub-channels of alarms are the **alarm base** and the **alarm range**.

1.6.1 Setting procedure

1 Using the keys , select the channel from which you wish to set an alarm.

2 Press **Ent** key until the list of sub-channels **HIGH ALARM**, **LOW ALARM** and **FILTERING** appears.

3 Then successively press **Ent** key to select the sub-channel **LOW ALARM** or **HIGH ALARM**.





4 Using the keys , set the new alarm value to "20".

5 Validate and exit the alarm menu by maintaining pressure on **Ent**. The new value is saved in memory.

Figure 2

1.6.2 Alarms activation procedure

After having set the alarms, you can activate or disable all the alarms.

- Using the keys  and , select the **CONFIG** channel,
- Press **Ent** key until the sub channel **valid alarm** appears,
- Using the keys  and , select **yes** or **no**,
- Push **Ent** key to validate,
- Exit the setting menu by maintaining pressure on **Ent** key or wait 10s and the SL50 will automatically exit the menu.

Note that you can stop the alarm during 10 minutes with a brief pressure on any key.

1.7 Filtering of the channels

The level of **filtering** of a channel determines the frequency of update of the data displayed.

For example, in rough sea when the boat moves significantly, it is useful to increase the filtering of the speed channel to stabilise the value displayed. Conversely, in calm sea, low filtering will be preferable to obtain a fast response of the display.

Filtering is adjustable between **1** and **32**, and the default value is **8**. The lower this value is, the higher the frequency of update is.

Filter setting procedure

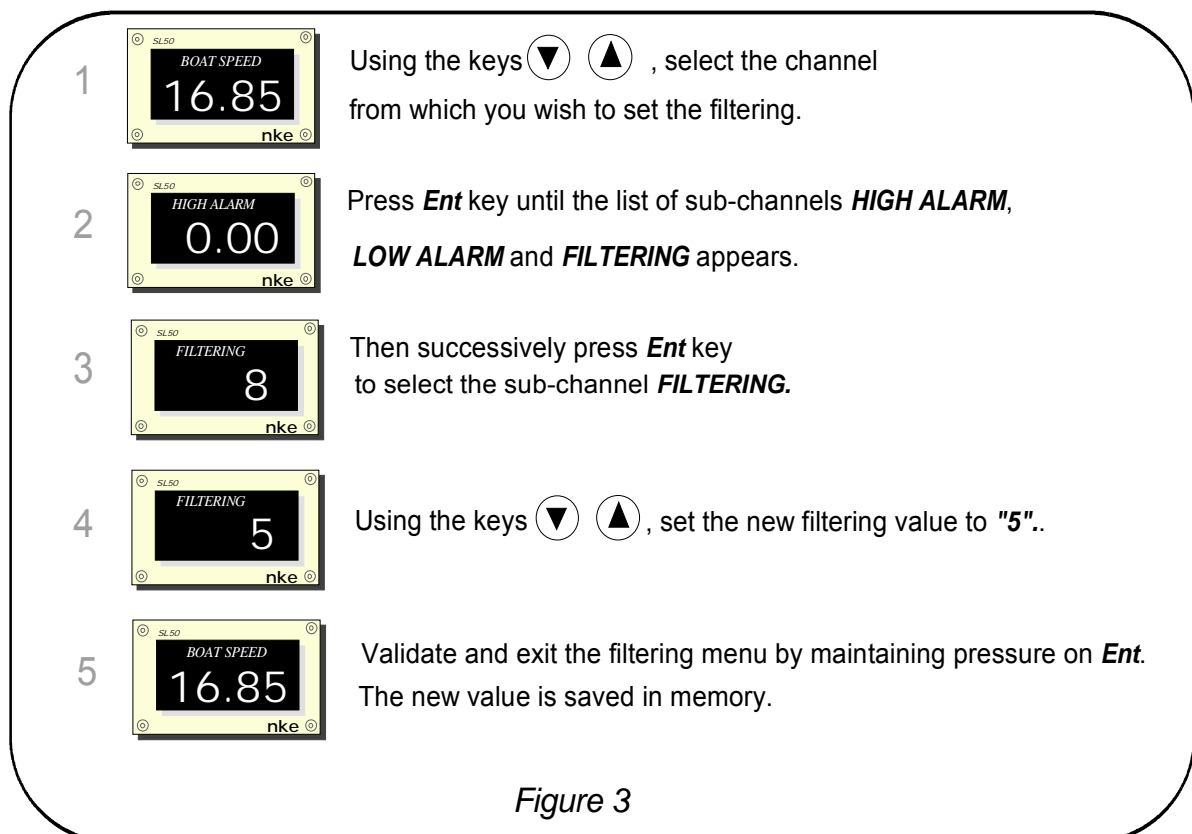



Figure 3

1.8 Lighting setting

The **SL50**, as well as the other displays of the **TOPLINE** range, have five levels of backlighting : 0 = no lighting, 1 corresponds to the minimum level of lighting and 4 to the maximum level. You have the option to set the level of lighting, either on the **SL50** only, or on every **TOPLINE** display of your installation :

1.8.1 SL50 setting procedure





- Press **Ent** key to enter LEVEL SETTING
- Using keys  and , set the lighting level from 0 to 4,
- After few seconds the SL50 exits automatically the menu. The setting is saved in memory.

1.8.2 Setting procedure for every display of your installation

Follow the above procedure, then press on the  key to apply the setting to every display.

1.8.3 Colour setting

The SL50 offers the option of a red or a green backlighting :





- Using the keys  and , select the **CONFIG** channel,
- Press **Ent** key to validate until the list of sub channels **Valid alarm**, **language** and **lighting** appears,
- Then successively press **Ent** key to select **lighting**,
- Using keys  and , select **green** or **red**,
- Press **Ent** to validate,
- Exit the setting menu by maintaining pressure on **Ent** key or wait 10s until the **SL50** exits automatically the menu. The new setting is saved in memory and is applied to all **SL50** of your installation.

1.9 Choice of the unit

You have the option to choose the display units of the channels:



- in knots or in km/hr for the log/speedometer,
- in knots or m/s for the anemometer,
- in degree Fahrenheit or in degree Celsius for the temperature,
- in meters or in feet for the depth finder.

Unit setting procedure

- Using keys  and , select the channel from which you wish to change the unit
- Press **Ent** key until the sub channel **Unit** appears,
- Using keys  and , select the unit and press **Ent** to validate,
- Exit the setting menu by maintaining pressure on the **Ent** key or wait 10s until the **SL50** exits automatically the menu. The new setting is saved in memory.

1.10 Choice of languages

You can configure the **SL50** in one of these six available languages : French, English, Italian, Spanish, German and Dutch.

- Using the keys  and , select the **CONFIG** channel,
- Press **Ent** key until the list of Sub-channels **valid alarm**, **language** and **lighting** appears,
- Successively press **Ent** key to select the chosen language,
- Press **Ent** to validate,



Exit the setting menu by maintaining pressure on **Ent** or wait 10s until the **SL50** automatically exit the menu. The new setting is saved in memory

1.11 Zero setting of the daily log

The channels **daily log** and **total log** are at your disposal on your display.

You will use the daily log to count the number of nautical miles completed during a sailing leg. The value is kept in memory when the power supply of your installation is cut off. Resetting the **daily log** channel to zero will allow you to count the number of nautical miles of the following sailing leg.

Zero setting procedure of the daily log





- using the keys  and , select the channel **daily log**,
- Press  until the log is set to 0.

The **total log** indicates the number of nautical miles completed since the installation of your **depth-finder log interface**. Only a complete initialisation of your **depth-finder log interface** allows to reset the **total log** to zero. It is performed by initialising the **surface speed** channel.

1.12 Use of the chronometer

The display includes a regatta chronometer. Times by default are T1= 6min and T2 = 4min.

1.12.1 Starting the chronometer









- Using the keys  and , select the **CHRONOMETER** channel,
- Press  until the **SL50** displays **6:00**; The chronometer is ready,
- Press  to start the chronometer: then the SL50 displays “**GO**”

During countdown, the last 5 seconds are signalled by a BEEP, then the START signal is given by the alarm.

Note that if you did not start the chronometer exactly at the start signal, you can synchronise the chronometer countdown at T2 by pressing the **Ent** key. During the procedure, you can also return to the initialisation value by pressing the **Ent** key for 2 seconds. The chronometer displays T1 = 6.00 minutes, for a new start.

1.12.2 Setting of T1 and T2

This setting can only be performed on the master display of your installation.

- select the **CHRONONOMETER** channel, using the  and  keys,
- press  until the message **T1 setting** appears,
- change the value of T1 using the  and  keys, then confirm with ,
- the message **T2 setting** appears,
- change the value of T2 using the  and  arrow keys, then confirm with the  key, after 5 seconds, the SL50 will automatically leave the setting mode.

2 CALIBRATION OF SENSORS

Every *nke* sensor is adjusted at the factory. However, a calibration is required to adapt the sensor to the specificities of your boat and to obtain an optimum measurement accuracy. Follow the calibration procedure below, by visualising the settings on a display.

Please refer to the installation notice of the **TOPLINE** sensor that you wish to calibrate.

2.1 Setting procedure of calibration coefficient

Example : you wish to set up the calibration coefficient of the **boat speed** channel at this value :1.1.

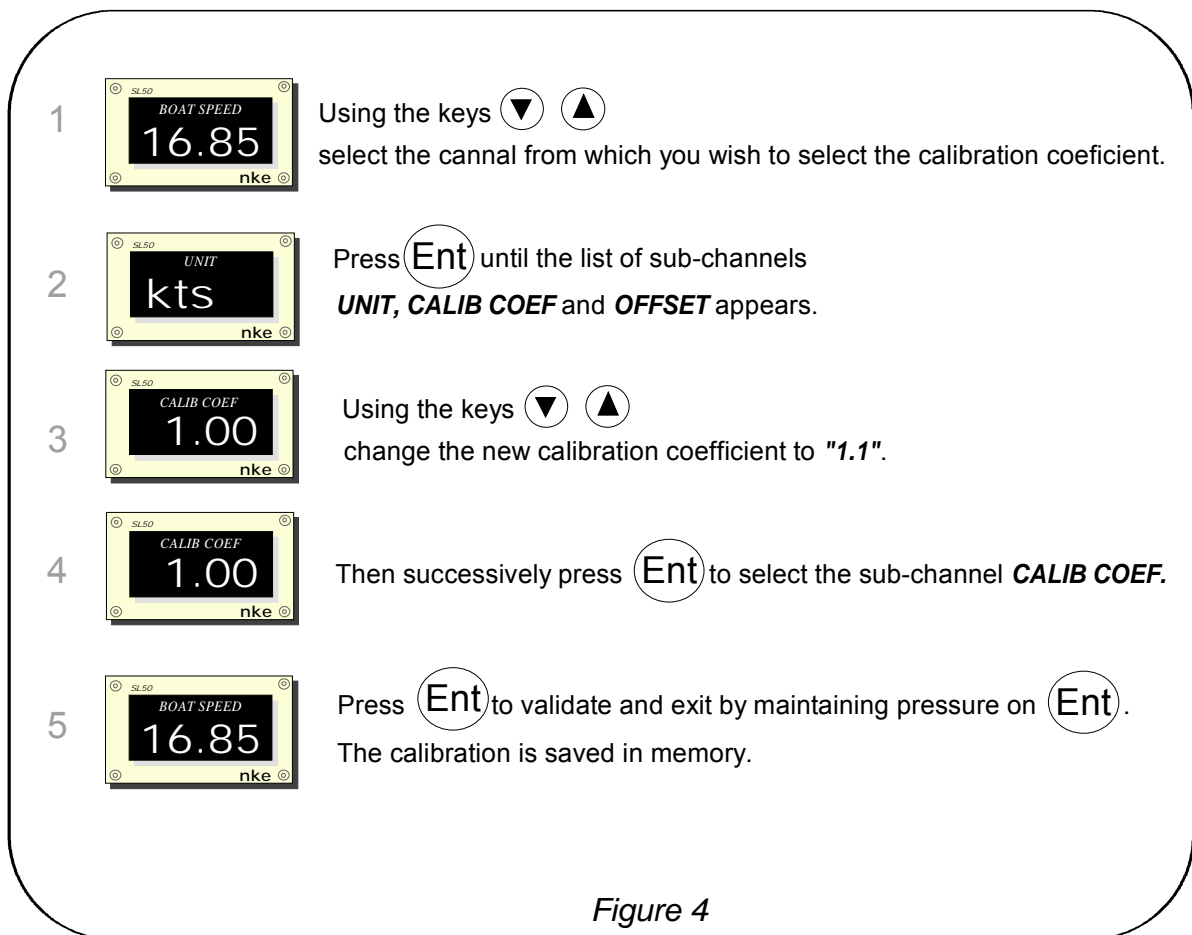

Figure 4

CAUTION :

- The **calib coef** parameter is a multiplier coefficient. This value must never be equal to zero. By default this coefficient is set to **1.00**. If it is not the case, before starting a calibration enter the value **1.00**.

2.2 Offset setting procedure

Follow the above procedure and choose the **OFFSET** sub-channel.

Note that this value is set to **0**.

2.3 Autocompensation of the fluxgate compass

Please refer to the compass user manual before starting the autocompensation procedure.

In order to achieve a successful autocompensation, you must navigate :

- On smooth sea, with no current and no wind.
- Away from large magnetic masses such as cargo boats.
- In an open area allowing the execution of a circle with a diameter approximately 5 times the length of the boat.
- At a constant speed of about 2 or 3 knots.

Procedure

1. Select the **magn head** channel,
2. Start to describe the circle, then press the 2 second on the key ▼, to launch the autocompensation procedure.
3. One single circle* is sufficient to perform the autocompensation correctly, when its a success, the message **3000** is indicated.

** For the previous generation of compass, referenced as 90-60-005, at least three circles must be executed.*

In case of problem during autocompensation, the **SL50** displays the **PAN** message , plus one code :

- Code 1 : cancellation at user request.
- Code 2 : detection of a gyration in the opposite direction. Start again clockwise.
- Code 3 : excessive variation between 2 heading measurements. Reduce the speed of your boat to 2 or 3 knots.
- Code 4 : angle correction higher than 20°. Start the autocompensation procedure over.

In case of autocompensation error, the measurements are not saved to the memory and the sensor resumes its normal operating mode.

2.4 Technical specifications

- Power supply : 10 to 16VDC
- Consumption : 20mA without lighting and 70mA with lighting.
- Tightness : IP67
- Weight : 1.150kg including cable
- Dimensions : height = 260mm ; width = 156mm ; thickness = 45mm
- Operating temperature : -10°C to +50°C
- Storage temperature : -20°C to +60°C
- Horizontal viewing angle : superior to 120°
- Vertical viewing angle : superior to 90°

Height of the characters displayed : 50 mm for the channel, and 10 mm for the identifier and the unit.

2.5 Version and address number of the display

You can check the software version of the display and its address in the list. In order to do that, select the CONFIGURATION channel, then press the **Ent** key for 5 seconds. The date, time and version of the SL50 software are then momentarily displayed on the screen.

To check what the version of your software is, select the CONFIG channel and press **Ent** key until "**nke SL50**" is displayed: The date, time and version of the SL50 software are then momentarily displayed on the screen. To read the address number, select the CONFIG channel and press the key  for 3 seconds.

2.6 Diagnostic for 1st level troubleshooting.

Before contacting technical support, please check the troubleshooting table below.

Problem	Possible causes and solutions
The Topline installation does not detect the SL50	The bus cable is not or is badly connected to the terminal box : check the plugging and the connection inside the terminal box. Check the state of the cables : they must not show any sign of wear or cut.
The remote control does not control the SL50	The address of the remote control is lower than that of the SL50 : reinitialise the remote control, see chapter 17. The SL50 is set at the address « 0 » : perform its initialisation, see chapter 17.
The SL50 displays the message « data wire error »	Check that the black data wire is connected at the right location in the terminal box : see chapter 17
The SL50 displays the message « collision error »	It is possible that there are two master displays (at address 1) on your installation : check the addresses, if it is the case, reinitialise one of the displays.
The SL50 does not display the NMEA data : that from the GPS for example.	Has the NMEA link been initialised ? see chapter 16 The NMEA link is not or is badly connected to the terminal box : check the connection of the SL50 and that of the NMEA transmitter (GPS).
Your display indicates battery fault .	Check the voltage of your battery with a voltmeter : the operating voltage must be higher than 10VDC. Check the charge behaviour of your battery.

If you do not manage to solve the problem, please contact your distributor.

2.7 SL50 initialisation : see chapter 4.8

3 INSTALLATION

This chapter describes the installation and the initialization of the **SL50**.

IMPORTANT

- Read this user guide entirely before starting the installation.
- Any electrical connection of the **SL50** on the **TOPLINE bus** must be carried out with the terminal box 90-60-417 (equipped with a connection terminal for the NMEA input).
- Only use **TOPLINE bus** cable of the type 20-61-001.
- Any intervention on the **TOPLINE bus** must be carried out with the installation power switched off.

3.1 Packing list :

- one Multifunction **SL50** equipped with ten meters of cable, including the **TOPLINE bus** and one **NMEA** input,
- one user guide,
- one protective cover
- four M4 fixing screws

3.2 List of accessories

- Standard terminal box TOPLINE bus : 90-60-121
- Terminal box TOPLINE bus with NMEA input : 90-60-417
- Cable remote control : 90-60-245
- Wireless remote control : 90-60-258

3.3 Installation precautions

The location of the **SL50** must be :

- so that the helmsman is able to easily read the data,
- placed in a location away from potential shocks,
- more than 40cm away from a magnetic compass,
- more than 1 meter away from a VHF radio transmitter.

The best readability of the **SL50** is generally obtained by mounting it on a mast foot support. You can also wall mount it on any flat surface of the boat.

Four M4x30mm fixing screws are provided with the SL50.

The support is an accessory available at your distributor.

3.4 Mounting on mast foot support

Make sure that the support you have chosen can be mounted on the mast of your boat. Check that there is sufficient space behind the partition to make the cable run.

If the cable runs inside the mast, make the cable pass through an opening equipped with a grommet. If the cable runs across the deck, make the cable pass through a tight stern tube gland.

3.4.1 Mounting procedure for the support

- place the support on the mast foot,
- using a pencil, locate the six fixing holes, then remove the support,
- using a centre punch, mark the centre of each hole,
- drill the holes with a diameter $\varnothing 5$,
- mount the support with the six fixing screws or six rivets (not included).

3.4.2 Mounting procedure of the **SL50** on the support

- drill a $\varnothing 18$ holes in the support (as indicated on Figure 5)
- Clean the mounting surface with alcohol,
- introduce the cable in the $\varnothing 18$ drilled hole,
- position the **SL50** so that it faces the four $\varnothing 4$ holes,
- place the four screws (provided with the product) in the holes, from the back of the partition,
- tighten the four fixing screws moderately.

CAUTION :

- When mounting the **SL50**, tighten the fixing screws moderately. Excessive tightening can cause the casing to break.
- Do not use glue putty to mount the **SL50**.

3.5 Wall mounting

Make sure the location is clean, smooth and flat. Check that there is sufficient space behind the partition to make the cable run.

Procedure

- Perform the drillings of figure 13 on the partition,
- Clean the mounting surface with alcohol,
- Lay a very thin silicone sealing joint around the mounting perimeter,
- introduce the cable in the $\varnothing 18$ drilled hole,
- position the **SL50** so that it faces the four $\varnothing 5$ holes,
- place the four screws (provided with the product) in the holes, from the back of the partition, tighten the four fixing screws moderately.

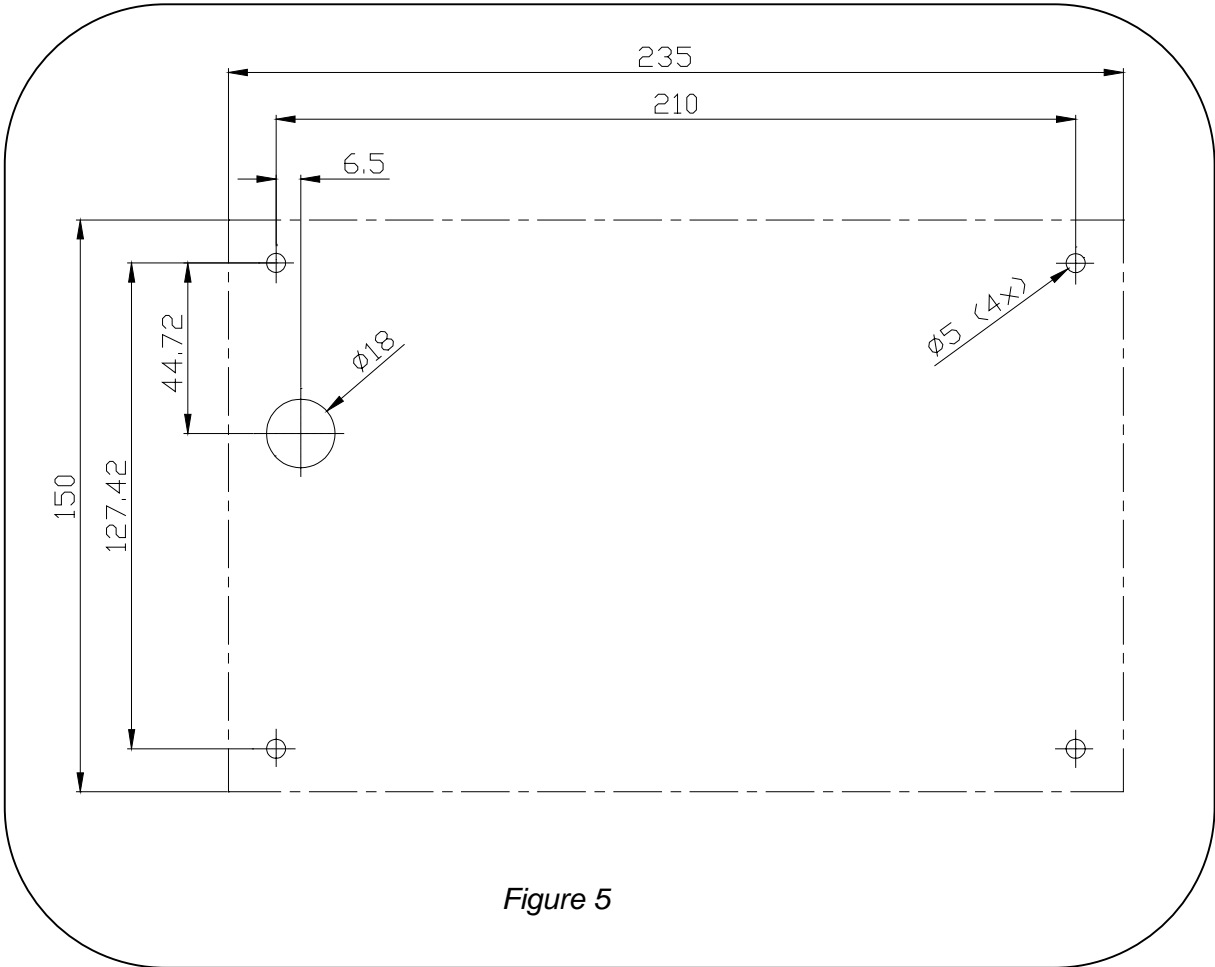
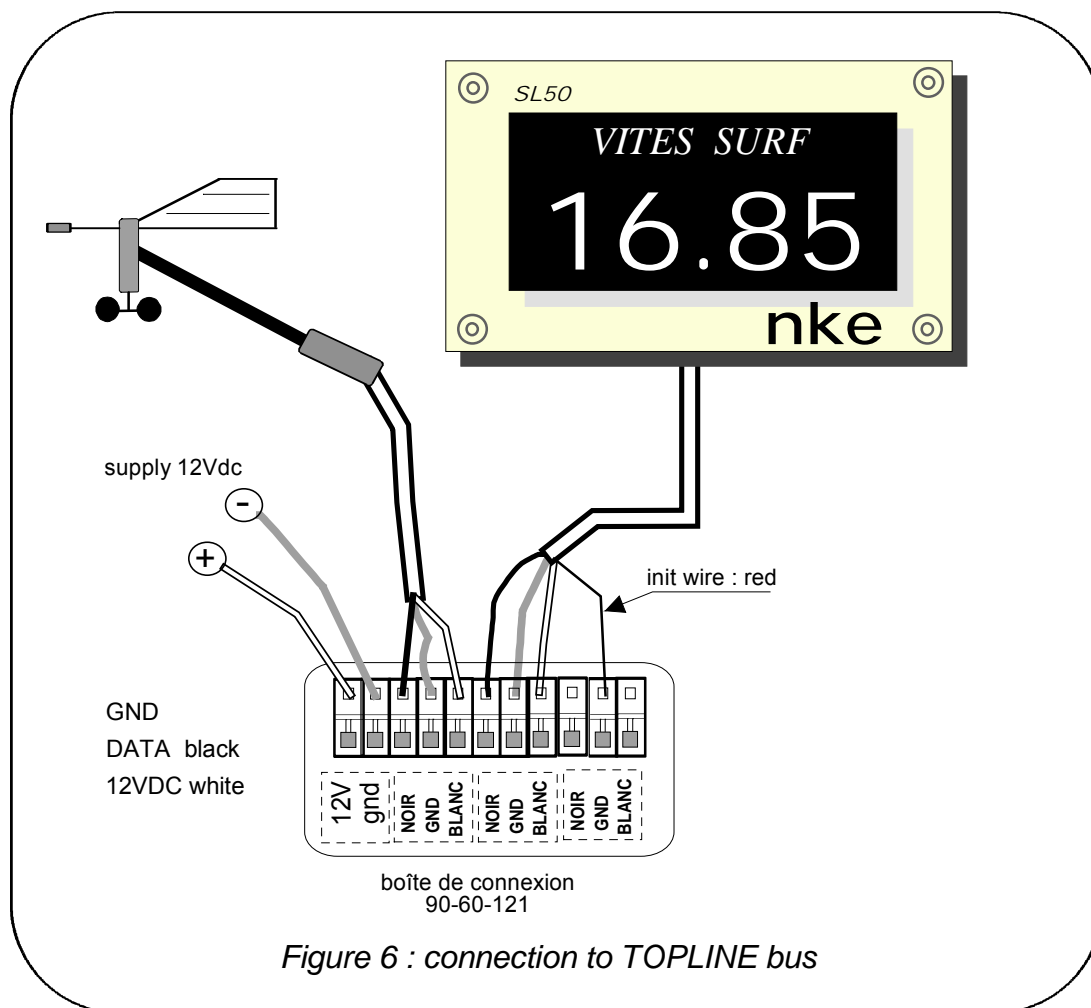

Figure 5

3.6 Connection to the *Topline bus*

1. Make the bus cable run from the **SL50** to the **TOPLINE** terminal box of your installation.
2. Connect the bus cable inside the terminal box.



If you reduce the length of the bus cable, strip and galvanise the wires before connecting them inside the terminal box.

3.7 Identification of the cable wires

White cable 6 wires	Wire identification	
White wire	+12V	TOPLINE Bus
Black wire	<i>Topline</i> Data	
Braid	Earth	
Red wire	Initialisation wire (GND)	

3.8 **SL50 and remote control initialisation**

At first power-up, you must initialise the **SL50** so that an address is assigned to it. The display is delivered with the address set as **0**. During the initialisation, it will automatically insert itself in the list of instruments and displays of the **TOPLINE bus** of your installation :

- either as master, at the address **1**, if this address is available on the bus,
- or as slave, if the address 1 is taken by a master, at an available address comprised between **2** and **20**.

Likewise, the remote controls must also be initialised. Please refer to the remote control user guide.

3.8.1 **Initialisation procedure:** the SL50 is set at the address **0**

- your installation is powered off : disconnect the initialisation red wire from the **init** terminal (GND),
- power up your installation : the **SL50** then performs an auto-test,
- when the message «**connect the red wire**» appears, reconnect the red wire on **init** (GND) : the **SL50** takes an address available on the bus,
- the SL50 is then initialised.

CAUTION :

- the remote control(s) of your installation must be assigned to an address higher than the one of the **SL50**. To achieve that, you must first initialise the **SL50** then the remote control(s).

3.8.2 **Reinitialisation procedure :** the SL50 already has an address between 1 and 20

You may need to reinitialise the **SL50**, for example to have another address assigned to it.

- your installation is powered off : disconnect the initialisation red wire from the **init** terminal (GND),
- power up your installation : the SL50 performs an auto-test then takes the address **0**,
- when the message «**connect the red wire**» appears, reconnect the red wire on **init** (GND) : the **SL50** takes an address available on the bus,
- the SL50 is then initialised.

